

Varenna Square Cord Set

SKU 1420xxx

IMPORTANT SAFETY INSTRUCTIONS

This portable luminaire has a polarized plug (one blade is wider than the other) as a feature to reduce the risk of electric shock. This plug will fit in a polarized outlet only one way. If the plug does not fit fully in the outlet, reverse the plug. If it still does not fit, contact a qualified electrician. Never use with an extension cord unless plug can be fully inserted. Do not alter the plug.

CONSIGNES DE SÉCURITÉ IMPORTANTES

Ce luminaire portable est doté d'une fiche polarisée (une lame est plus large que l'autre) fonction pour réduire le risque de choc électrique. Cette fiche s'insère dans une prise polarisée d'une seule façon. Si la fiche n'entre pas complètement dans la prise, retournez la fiche. Si elle ne rentre toujours pas, contactez un électricien qualifié. N'utilisez jamais avec un cordon d'extension sauf si la prise est entièrement insérée. Ne pas modifier la fiche.

INSTRUCCIONES IMPORTANTES DE SEGURIDAD

Esta luminaria portable utiliza una clavija polarizada (una de las terminales es más ancha que la otra) como característica para reducir el riesgo de descarga eléctrica. Esta clavija embonará en un único sentido dentro de un enchufe polarizado. Si la clavija no entra por completo en el enchufe, invierte el sentido de la clavija. Si no embona, contacte a un eléctrico calificado. Nunca utilice la lámpara con una extensión al menos que la clavija entre perfectamente. No altere la clavija.

THIS DEVICE COMPLIES WITH PART 15 OF THE FCC RULES. OPERATION IS SUBJECT TO THE FOLLOWING TWO CONDITIONS:

(1) THIS DEVICE MAY NOT CAUSE HARMFUL INTERFERENCE, AND (2) THIS DEVICE MUST ACCEPT ANY INTERFERENCE RECEIVED, INCLUDING INTERFERENCE THAT MAY CAUSE UNDESIRE OPERATION

NOTE: THIS EQUIPMENT HAS BEEN TESTED AND FOUND TO COMPLY WITH THE LIMITS FOR A CLASS B DIGITAL DEVICE, PURSUANT TO PART 15 OF THE FCC RULES. THESE LIMITS ARE DESIGNED TO PROVIDE REASONABLE PROTECTION AGAINST HARMFUL INTERFERENCE IN A RESIDENTIAL INSTALLATION. THIS EQUIPMENT GENERATES, USES AND CAN RADIATE RADIO FREQUENCY ENERGY AND, IF NOT INSTALLED AND USED IN ACCORDANCE WITH THE INSTRUCTIONS, MAY CAUSE HARMFUL INTERFERENCE TO RADIO COMMUNICATIONS. HOWEVER, THERE IS NO GUARANTEE THAT INTERFERENCE WILL NOT OCCUR IN A PARTICULAR INSTALLATION. IF THIS EQUIPMENT DOES CAUSE HARMFUL INTERFERENCE TO RADIO OR TELEVISION RECEPTION, WHICH CAN BE DETERMINED BY TURNING THE EQUIPMENT OFF AND ON, THE USER IS ENCOURAGED TO TRY TO CORRECT THE INTERFERENCE BY ONE OR MORE OF THE FOLLOWING MEASURES:

- REORIENT OR RELOCATE THE RECEIVING ANTENNA.
- INCREASE THE SEPARATION BETWEEN THE EQUIPMENT AND RECEIVER.
- CONNECT THE EQUIPMENT INTO AN OUTLET ON A CIRCUIT DIFFERENT FROM THAT TO WHICH THE RECEIVER IS CONNECTED.
- CONSULT THE DEALER OR AN EXPERIENCED RADIO/TV TECHNICIAN FOR HELP. CHANGES OR MODIFICATIONS NOT EXPRESSLY APPROVED BY THE PARTY RESPONSIBLE FOR COMPLIANCE COULD VOID THE USER'S AUTHORITY TO OPERATE THE EQUIPMENT.

CAN ICES-005 (B) / NMB-005 (B)

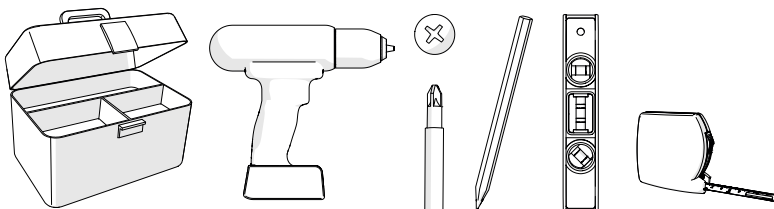
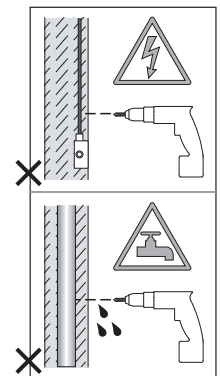

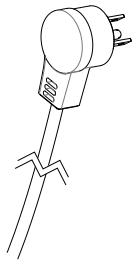

Cord Set Installation
 Installation du jeu de cordons
 Instalación del juego de cables

1

Electrical work should be performed with the power OFF on the respective circuit and be conducted by a licenced professional.

Les travaux électriques doivent être effectués avec le hors tension sur le circuit et être conduit par un professionnel agréé.

El trabajo eléctrico debe ser realizado con el apague el respectivo circuito y ser conducido por un profesional con licencia.

DANGER - RISK OF SHOCK - Disconnect power before installation

DANGER - RISQUE DE CHOC - Couper l'alimentation avant l'installation

2

Measure the width across the hole centres on the top and bottom vertical slots on the mirror.

Mesurez la largeur à travers les centres de trou sur les fentes verticales du haut et du bas sur le miroir.

Mida el ancho a través de los centros de taladro en las ranuras verticales superior e inferior del espejo.

3

A

B

Mark the slotted holes on the wall brackets. As a minimum, use the top and bottom holes. Use more if needed. For maximum support, locate and fix to a wooden stud.

Marquez les trous oblongs sur les supports muraux. Au minimum, utilisez les trous du haut et du bas. Utilisez plus si nécessaire. Pour un soutien maximal, localisez et fixez sur un montant en bois.

Marque los orificios ranurados en los soportes de pared. Como mínimo, use los orificios superior e inferior. Use más si es necesario. Para obtener el máximo apoyo, ubíquelo y fíjelo a un montante de madera.

4

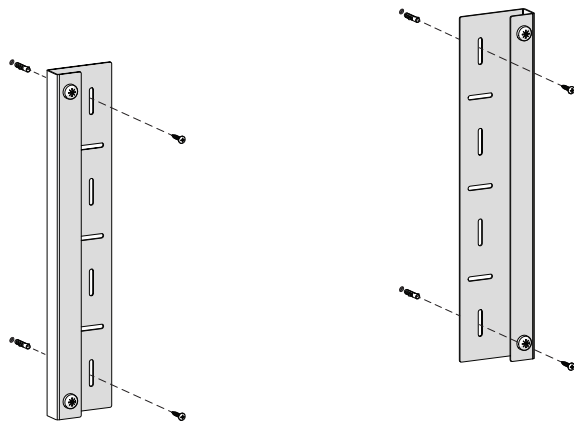

Fixings not included.
Use suitable fixings for wall type.

Fixations non incluses.
Utilisez des fixations adaptées au type de mur.

Fijaciones no incluidas.
Utilice fijaciones adecuadas para el tipo de pared.

5

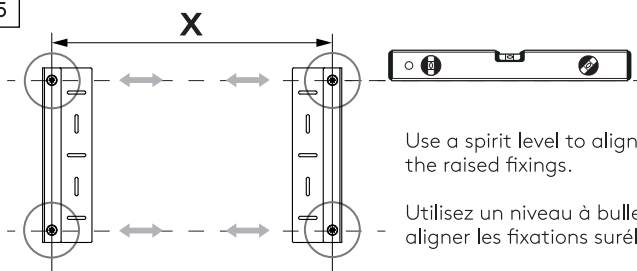

Use a spirit level to align the raised fixings.

Utilisez un niveau à bulbe pour aligner les fixations surélevées.

Utilice un nivel de burbuja para alinear las fijaciones elevadas.

Check the centre of the raised fixings on the wall brackets and ensure they match the mirror. Adjust if necessary.

Vérifiez le centre des fixations surélevées sur les supports muraux et assurez-vous qu'ils correspondent au miroir. Ajustez si nécessaire.

Verifique el centro de las fijaciones elevadas en los soportes de pared y asegúrese de que coincidan con el espejo. Ajústelo si es necesario.

6

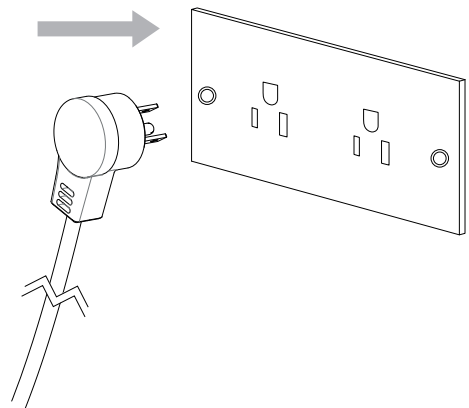

7

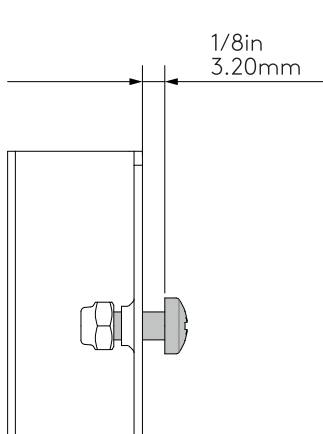

Ensure the fixings are raised by at least 1/8in (3.2mm).

Assurez-vous que les fixations sont surélevées d'au moins 1/8in (3.2mm).

Asegúrese de que las fijaciones estén elevadas al menos 1/8 pulg. (3,2 mm).

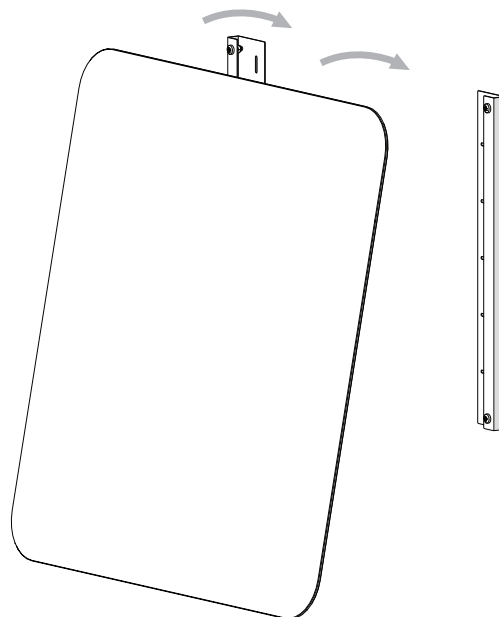

Product Weight /
Poids du produit / 14.9 Kg
Peso del producto

