

# Elba Wall

astro

SKU 1469xxx

## INSTALLATION INSTRUCTIONS / INSTRUCTIONS D'INSTALLATION / INSTRUCCIONES DE INSTALACIÓN

**EN** PLEASE READ THE INSTRUCTIONS CAREFULLY

**THIS PRODUCT MUST BE INSTALLED IN ACCORDANCE WITH THE APPLICABLE INSTALLATION CODE BY A PERSON FAMILIAR WITH THE CONSTRUCTION AND OPERATION OF THE PRODUCT AND THE HAZARDS INVOLVED. CONSULT A QUALIFIED ELECTRICIAN TO ENSURE CORRECT BRANCH CIRCUIT CONDUCTOR.**

**FR** LIRE ATTENTIVEMENT LES INSTRUCTIONS AVANT DE COMMENCER LE MONTAGE

**CE PRODUIT DOIT ÊTRE INSTALLÉ SELON LE CODE D'INSTALLATION PERTINENT, PAR UNE PERSONNE QUI CONNAÎT BIEN LE PRODUIT ET SON FONCTIONNEMENT AINSI QUE LES RISQUES INHÉRENTS. CONSULTER UN ÉLECTRICIEN QUALIFIÉ POUR VOUS ASSURER QUE LES CONDUCTEURS DE LA DÉRIVATION SONT ADÉQUATS.**

**ES** LEA DETENIDAMENTE LAS INSTRUCCIONES

**ESTE PRODUCTOR DEBE SER INSTALADO SEGUN EL CODIGO DE INSTALACION APLICABLE POR UNA PERSONA QUE CONOZCA LE CONSTUSSION Y EL FUNCIONAMIENTO DEL PRODUCTO Y LOS RIESGOS QUE SUPONE. CONSULTAR A UN ELECTRICISTA CALIFICADO PARA ASEGURAR LA ELECCION DEL CONDUCTOR DE CIRCUITO DERIVADO.**

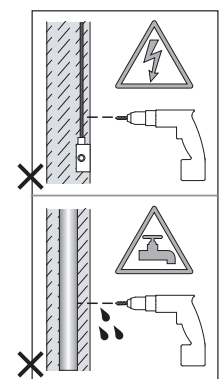

Wall mount only  
Installation murale seulement  
Exclusivamente para fijacion en muro

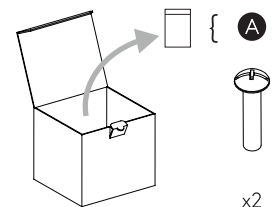
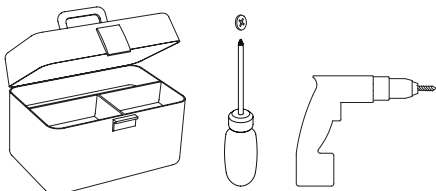

1

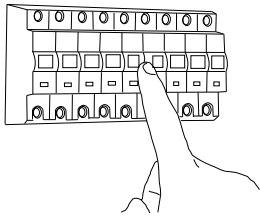

Turn off power  
Couper le courant! /  
Spegnere la corrente! /  
Strom Abshalten!

2

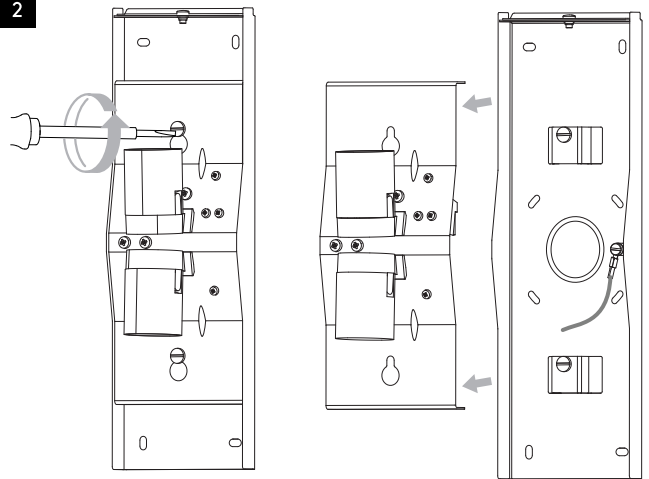

3

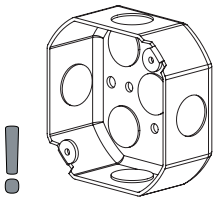

Junction box is not included  
La boîte de jonction n'est pas incluse  
La caja de conexión no está incluida

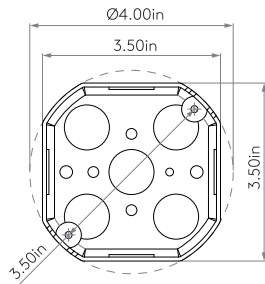

4

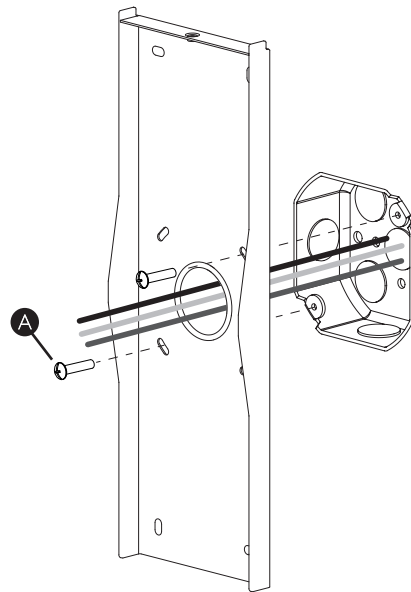

5

WHITE SUPPLY WIRE / NEUTRAL	WHITE OR IDENTIFIED FIXTURE WIRE UL LISTED WIRE NUTS	FILS DE COURANT BLANC / NEUTRE	FILS DE CONNECTEUR BLANC OU IDENTIFIABLE ÉCROUS DE FIL HOMOLOGUÉS UL	CABLE DE SUMINISTRO BLANCO / NEGATIVO	CABLE A LÁMPARA BLANCO / NEGATIVO
BLACK SUPPLY WIRE	PLAIN OR BLACK FIXTURE WIRE	FILS DE COURANT NOIR	FILS DE CONNECTEUR NOIR OU SANS MARQUES	CABLE DE SUMINISTRO NEGRO	CABLE A LÁMPARA NEGRO
BARE, OR GREEN GROUND WIRE FROM SUPPLY	BARE, OR GREEN FIXTURE GROUND WIRE	FILS VERT OU NEUTRE DU COURANT	FILS VERT OU NEUTRE	CABLE DESNUDO / VERDE TIERRA FÍSICA DEL SUMINISTRO	CABLE A LÁMPARA VERDE / TIERRA FÍSICA

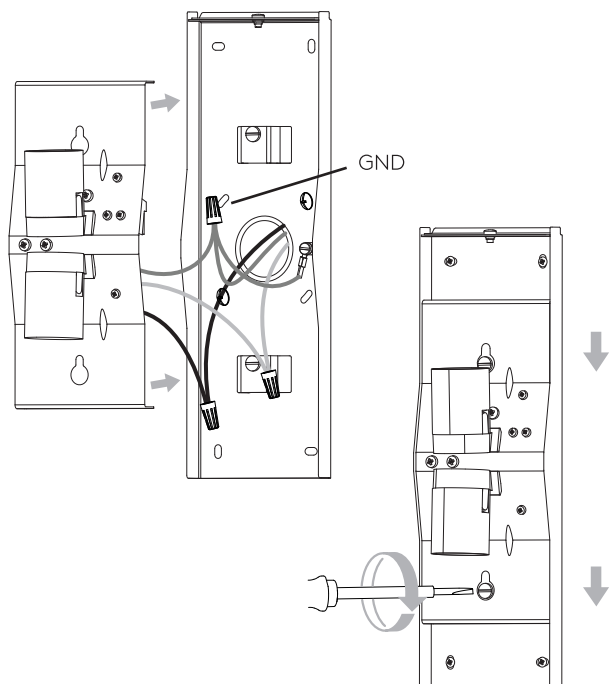

Use the appropriate UL listed wire nut for the number of conductors in the installation / Utilisez l'écrou de fil homologué UL approprié pour le nombre de conducteurs dans l'installation / Utilice el cono eléctrico apropiado listado por UL para la cantidad de conductores en la instalación

6

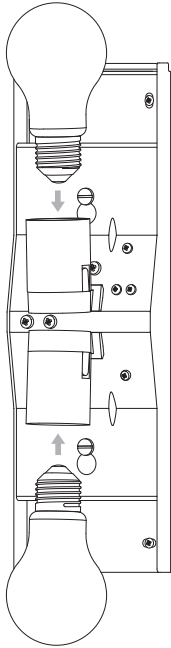

7

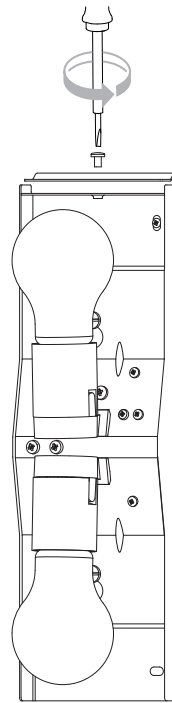

8

A

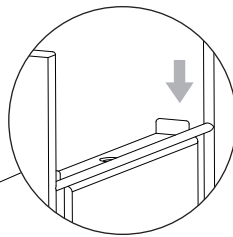
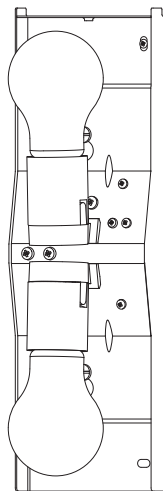
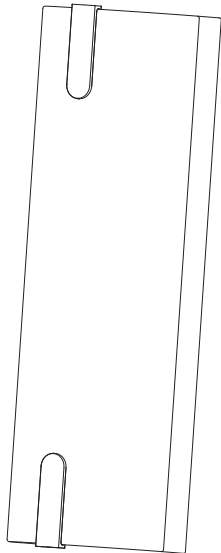

B

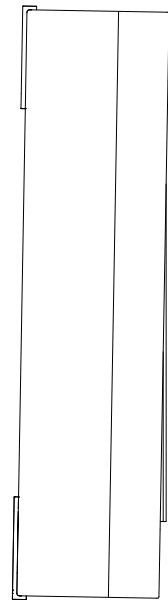

'Click'

9

