

# ENNA WALL LED (CORD SET)

astro

SKU 1058xxx

## IMPORTANT SAFETY INSTRUCTIONS

This portable luminaire has a polarized plug (one blade is wider than the other) as a feature to reduce the risk of electric shock. This plug will fit in a polarized outlet only one way. If the plug does not fit fully in the outlet, reverse the plug. If it still does not fit, contact a qualified electrician. Never use with an extension cord unless plug can be fully inserted. Do not alter the plug.

An opening for the attachment plug and supply cord is to be made in a location that will not allow the cord to be crushed if the headboard is pushed against the wall. If spacers or similar means are needed to prevent cord crushing, instructions for acquiring and installing such spacers on the headboard shall be provided.

If the headboard is constructed of materials with sharp edges that could damage the cord such as metal or glass, the opening should have smooth round holes, or a plastic bushing shall be inserted to protect the cord.

The National Electrical Code, ANSI/NFPA 70, does not permit cords to be concealed where damage to the insulation may go unnoticed. To prevent fire danger, do not run cord where it may be inaccessible for examination. Cords should be visually examined periodically and immediately replaced when any damage is noted.

Spacers or similar means shall be provided on the headboard so that the cord will not be pinched or damaged if the headboard is pushed against the wall.

Use only insulated staples or plastic ties to secure cords.

## CONSIGNES DE SÉCURITÉ IMPORTANTES

Ce luminaire portable est doté d'une fiche polarisée (une lame est plus large que l'autre) fonction pour réduire le risque de choc électrique. Cette fiche s'insère dans une prise polarisée d'une seule façon. Si la fiche n'entre pas complètement dans la prise, retournez la fiche. Si elle ne rentre toujours pas, contactez un électricien qualifié. N'utilisez jamais avec un cordon d'extension sauf si la prise est entièrement insérée. Ne pas modifier la fiche.

## INSTRUCCIONES IMPORTANTES DE SEGURIDAD

Esta luminaria portable utiliza una clavija polarizada (una de las terminales es más ancha que la otra) como característica para reducir el riesgo de descarga eléctrica. Esta clavija embonará en un único sentido dentro de un enchufe polarizado. Si la clavija no entra por completo en el enchufe, invierta el sentido de la clavija. Si no embona, contacte a un eléctrico calificado. Nunca utilice la lámpara con una extensión al menos que la clavija entre perfectamente. No altere la clavija.

THIS DEVICE COMPLIES WITH PART 15 OF THE FCC RULES. OPERATION IS SUBJECT TO THE FOLLOWING TWO CONDITIONS:

(1) THIS DEVICE MAY NOT CAUSE HARMFUL INTERFERENCE, AND (2) THIS DEVICE MUST ACCEPT ANY INTERFERENCE RECEIVED, INCLUDING INTERFERENCE THAT MAY CAUSE UNDESIRE OPERATION

**NOTE:** THIS EQUIPMENT HAS BEEN TESTED AND FOUND TO COMPLY WITH THE LIMITS FOR A CLASS B DIGITAL DEVICE, PURSUANT TO PART 15 OF THE FCC RULES. THESE LIMITS ARE DESIGNED TO PROVIDE REASONABLE PROTECTION AGAINST HARMFUL INTERFERENCE IN A RESIDENTIAL INSTALLATION. THIS EQUIPMENT GENERATES, USES AND CAN RADIATE RADIO FREQUENCY ENERGY AND, IF NOT INSTALLED AND USED IN ACCORDANCE WITH THE INSTRUCTIONS, MAY CAUSE HARMFUL INTERFERENCE TO RADIO COMMUNICATIONS. HOWEVER, THERE IS NO GUARANTEE THAT INTERFERENCE WILL NOT OCCUR IN A PARTICULAR INSTALLATION. IF THIS EQUIPMENT DOES CAUSE HARMFUL INTERFERENCE TO RADIO OR TELEVISION RECEPTION, WHICH CAN BE DETERMINED BY TURNING THE EQUIPMENT OFF AND ON, THE USER IS ENCOURAGED TO TRY TO CORRECT THE INTERFERENCE BY ONE OR MORE OF THE FOLLOWING MEASURES:

- REORIENT OR RELOCATE THE RECEIVING ANTENNA.
- INCREASE THE SEPARATION BETWEEN THE EQUIPMENT AND RECEIVER.
- CONNECT THE EQUIPMENT INTO AN OUTLET ON A CIRCUIT DIFFERENT FROM THAT TO WHICH THE RECEIVER IS CONNECTED.
- CONSULT THE DEALER OR AN EXPERIENCED RADIO/TV TECHNICIAN FOR HELP. CHANGES OR MODIFICATIONS NOT EXPRESSLY APPROVED BY THE PARTY RESPONSIBLE FOR COMPLIANCE COULD VOID THE USER'S AUTHORITY TO OPERATE THE EQUIPMENT.

### CAN ICES-005 (B) / NMB-005 (B)



HEADBOARD ONLY  
Tête de lit uniquement  
Cabecero solamente



UNSUITABLE FOR DIMMING  
Ne convient pour gradateur  
No es adecuado para dimmer

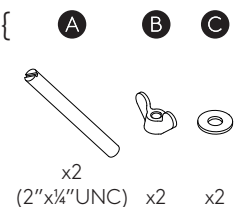
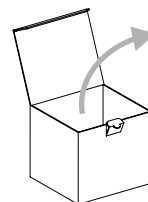
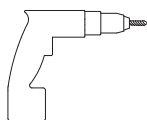
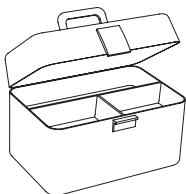

1

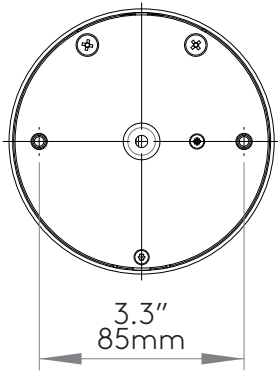

2

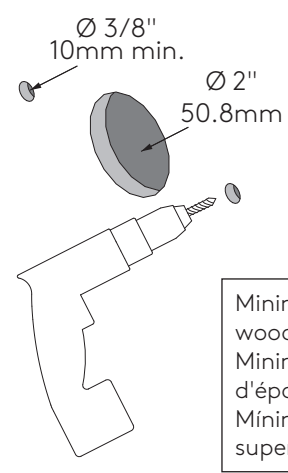

Minimum 1/2"/12,7mm thick  
wooden surface /  
Minimum 1/2 "/12,7 mm  
d'épaisseur surface en bois /  
Mínimo 1/2 "/12,7 mm de grosor  
superficie de madera

3

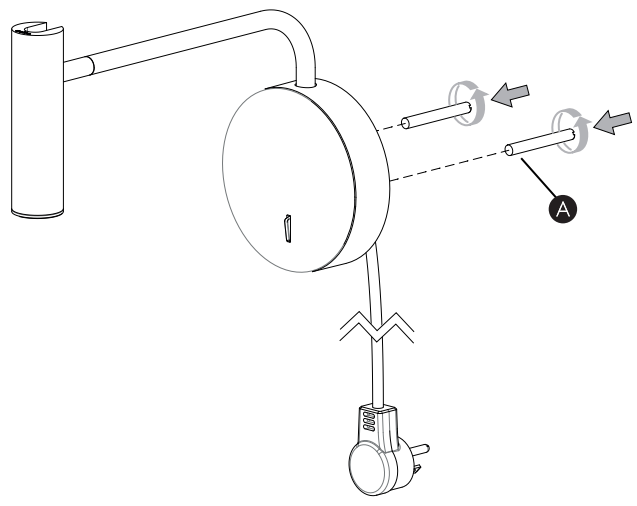

4

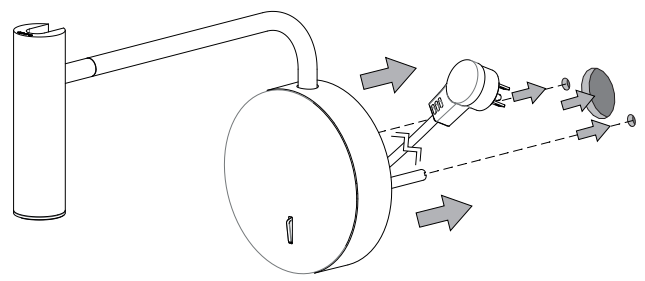

5

